

Article number: 20193B20V20502BL
 Description: E+G T-angle clamp
 GN 193-B20-V20-50-2-BL

Measures

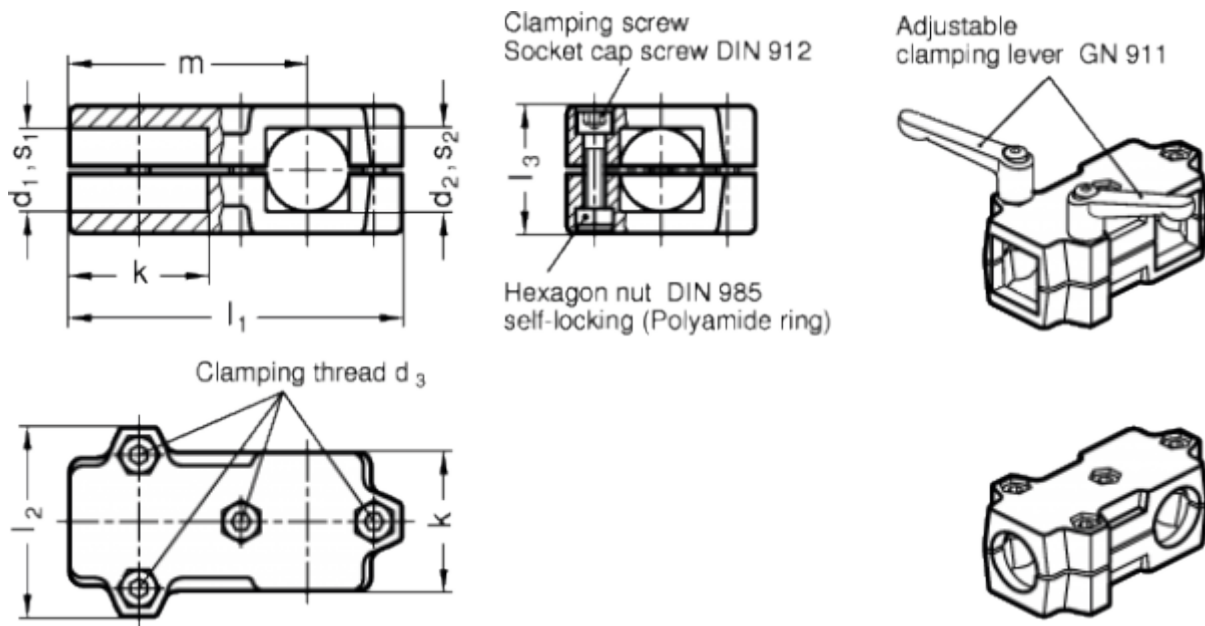

Accessories = GN 911-M8-40	m	= -
d1 = 20	s1	= -
d2 = -	s2	= 20
d3 = M8	Weight in (g)	= 476
k = 50		
l1 = 120		
l2 = 68		
l3 = 46		